

212 WEIGHT INDICATOR

212-1S

0.8" LCD Display
1x DC Power Conn.
1x I/O Conn.
1x Load Cell Conn.



212X-1S

2" LCD Display
1x DC Power Conn.
1x I/O Conn.
1x Load Cell Conn.

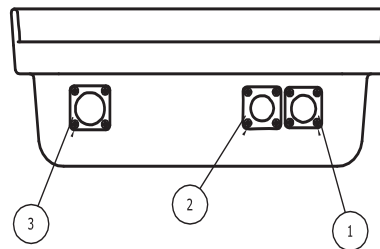
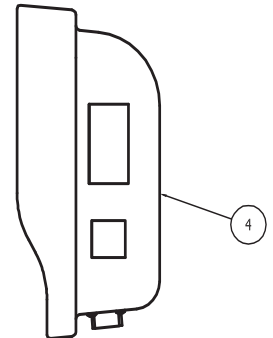

212-4S

0.8" LCD Display
1x DC Power Conn.
1x I/O Conn.
4x Load Cell Conn.



212X-4S

2" LCD Display
1x DC Power Conn.
1x I/O Conn.
4x Load Cell Conn.

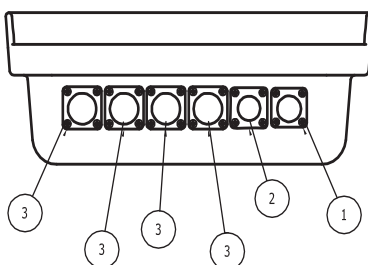
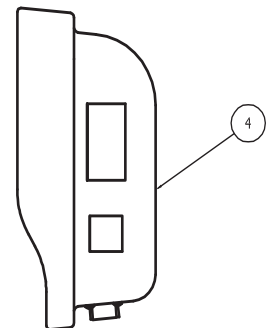

Option 1 - Power

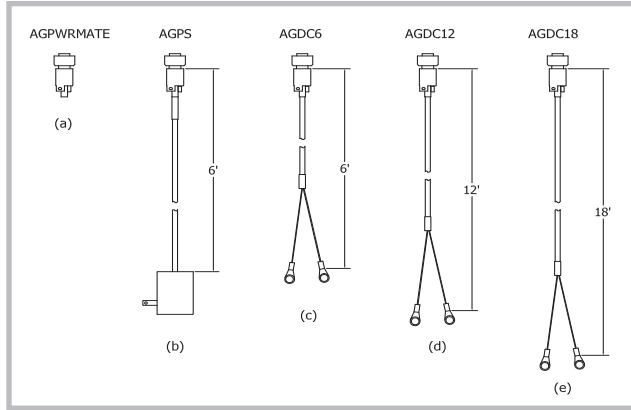

Option 2 - I/O

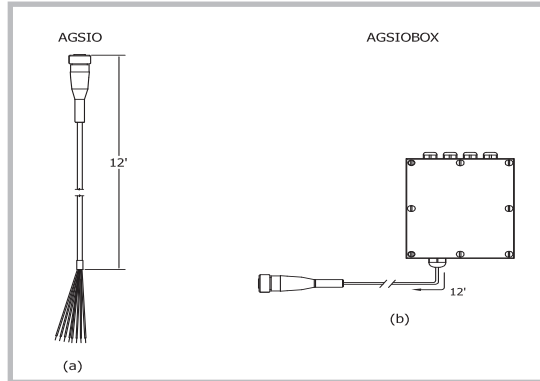

Option 3 - Load Cell

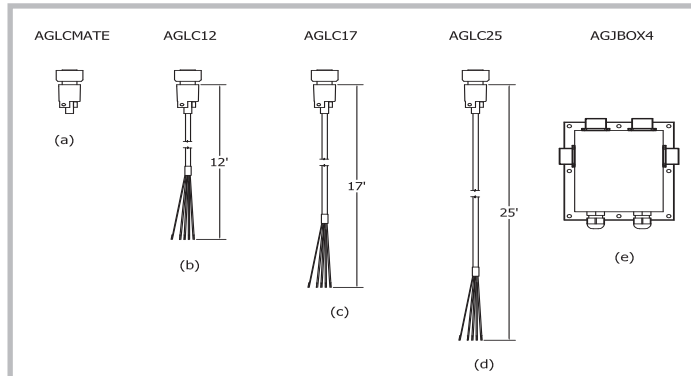

Option 4 - Mounting

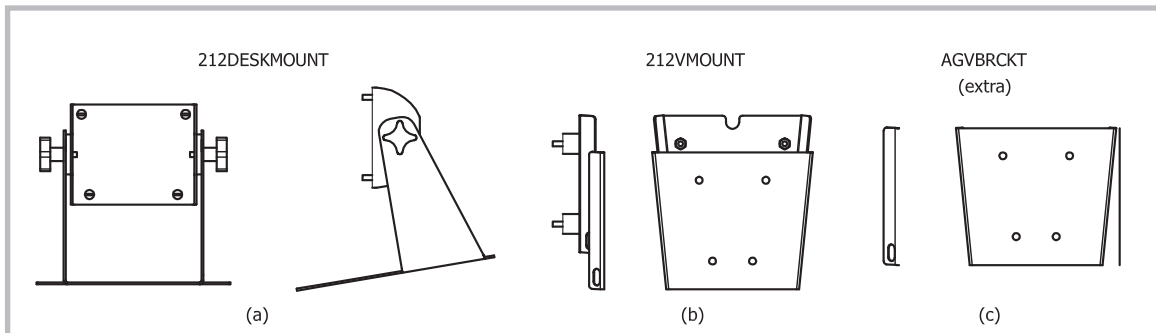

Cardinal Scale reserves the right to improve, enhance or modify features and specifications without prior notice. All registered trademarks are the property of their respective owners.

SOLD BY:

Cardinal
 Cardinal Scale Manufacturing Co.
 203 E. Daugherty, Webb City, MO 64870 USA
 Ph: 417-673-4631 or 800-441-4237 • Fax: 417-673-5001
www.CardinalScale.com